



CANTON METALWORK S.A

Fábrica de Bisagras y Herrajes para Obras

Bisagras a munición / Tipo Munición
Fichas / Pomelas
Para Herrero y Carpintero
Hierro , Bronce y Acero Inoxidable.

**AV. BARTOLOME MITRE 3999 – CASEROS (CP:1678) –
BUENOS AIRES – ARGENTINA.**

TEL/FAX: (54-11)4750-2040 /4750-0396/4750-3963

Whatsapp: +54 11 2527 1719

Email: ventascanton@gmail.com



<u>HIERRO</u>		Pag.	Ref.
MUNICION	CON AGUJEROS	1	1.A
	SIN AGUJEROS	1	1.B
	CON AGUJEROS 1 ALA CORTA	1	1.C
	SIN AGUJEROS 1 ALA CORTA	1	1.D
	CORTADAS	1	1.E
	DOBLE CONTACTO	1	1.F
TIPO MUNICION	CON AGUJEROS	2	2.D
	SIN AGUJEROS	2	2.E
	CON AGUJEROS 1 ALA CORTA	3	3.A
	SIN AGUJEROS 1 ALA CORTA	3	3.B
	CORTADAS	1	1.E
	DOBLE CONTACTO	2	2.D
POMELAS	TIPO 110 mm perilla Canton	5	5.C
	TIPO 110 mm perilla Estilo	5	5.D
	TIPO H	13	13.A.B
CARROCERAS	5	5.A
FICHAS	TRAFILADA PARA SOLDAR	5	5.B
	PARA CARPINTERIA DE ALUMINIO	6	6.D
	PARA CARPINTERO EN 1,5 / 2 / 2,5 mm	6	6.E
	MIXTAS PARA HERRERO	7	7.A
	HERRERO SIN AGUJERO EN 1,5 / 2 / 2,5 mm	7	7.B
	PARA MUEBLE	8	8.A
	PARA MUEBLE MIXTA	8	8.C
	PARA MUEBLES 5005	8	8.E.F.G
	PARA MUEBLES TIPO "1842"	9	9.B
	PESTAÑA N° 3 y N° 4°	9	9.C
	5005 IMPORTADAS	13	13.D
LINEA 3 RODAMIENTOS	4	4.A.B.C
<u>BRONCE</u>	MUNICION		
	ESTILO	2	2.A
	PERILLA CANTON	2	2.B
	TIPO MUNICION	3	3.C.D
	POMELAS		
	Canton	6	6.A.B.C
	Tipo H	14	14.A.B
	FICHAS		
	PARA CARPINTERO EN 1,25/ 1,5 / 2 mm	6	6,F
	PARA MUEBLE	8	8.B
	PARA MUEBLES 5005	9	9.A
	LINEA 3 RODAMIENTOS	4	4
<u>ACERO INOXIDABLE</u>	MUNICION	12	12.A.B.C
	CARROCERAS	14	14.B
	FICHA	14	14.E
	PARA PLEGADIZAS	14	14.A
	POMELA		
	C/cierre automático	14	14.C
	Tipo H	13	13.A.B
	Tradicional	14	14.D
	SIMIL BRONCE	12	12.D
	BISAGRA PIANO	13	13.C
	DOBLE Y SIMPLE ACCIO	15	15.A.B
ACCESORIOS	10	10.A.B
MANIJAS DOBLE BALANCIN	16	
MANIJONES / BARRALES CURVOS	17	17.A
MANIJONES RECTOS	17	17.B
NUMEROS Y LETRAS EN ACERO INOXIDABLE	18	18
SEÑALETICA EN ACERO INOXIDABLE	19	19



CANTON METALWORK S.A.

Artículo	Tipo	Descripción	A mm	B mm	C mm	D mm	Embalaje x Par	Ø Perno
----------	------	-------------	------	------	------	------	----------------	---------

1.A Bisagras Munición Con Agujeros Hro. Zincado

105	78x78x3	2 Rulemanes.	78	31	31	14	12	7,5
110	100x75x3	2 Rulemanes.	100	31	31	14	12	7,5
115	100x88x3	2 Rulemanes.	100	37	37	14	12	7,5
120	100x100x3	2 Rulemanes.	100	42	42	14	10	7,5
130	124x100x3	4 Rulemanes.	124	41	41	14	10	7,5
135	145x120x4	4 Rulemanes.	145	51	51	18	5	9,5
140	175x130x4	3 Rulemanes.	175	55	55	18	5	9,5
141	100x88x3	2 Rul./ Per.Seguridad	100	37	37	14	10	7,5

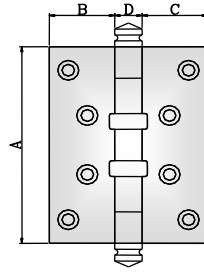

1.B Bisagras Munición Sin Agujeros Hro. Pulido

150	78x78x3	2 Rulemanes.	78	31	31	14	12	7,5
155	100x75x3	2 Rulemanes.	100	31	31	14	12	7,5
160	100x88x3	2 Rulemanes.	100	37	37	14	12	7,5
165	100x100x3	2 Rulemanes.	100	42	42	14	10	7,5
175	124x100x3	4 Rulemanes.	124	41	41	14	10	7,5
180	145x120x4	4 Rulemanes.	145	51	51	18	5	9,5
185	175x130x4	3 Rulemanes.	175	55	55	18	5	9,5

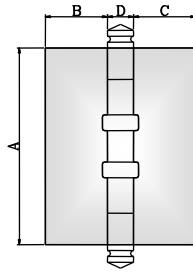

1.C Bisagras Munición Con Agujeros 1 Ala Corta Hro. Zincado

195	78x54x3	2 Rulemanes.	78	31	9	14	12	7,5
200	100x54x3	2 Rulemanes.	100	31	9	14	12	7,5
205	100x62x3	2 Rulemanes.	100	37	9	14	12	7,5
210	100x65x3	2 Rulemanes.	100	42	9	14	10	7,5
212	124x65x3	4 Rulemanes.	124	41	9	18	10	7,5
214	145x85x4	4 Rulemanes.	145	51	9	18	5	9,5

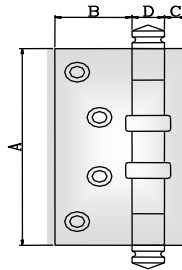

1.D Bisagras Munición sin Agujeros 1 Ala Cortada Hro. Pulido

215	78x54x3	2 Rulemanes.	78	31	9	14	12	7,5
220	100x54x3	2 Rulemanes.	100	31	9	14	12	7,5
225	100x62x3	2 Rulemanes.	100	37	9	14	12	7,5
230	100x65x3	2 Rulemanes.	100	42	9	14	10	7,5
232	124x65x3	4 Rulemanes.	124	41	9	18	10	7,5
234	145x85x4	4 Rulemanes.	145	51	9	18	5	9,5

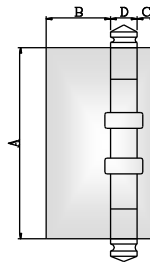

1.E Bisagras Cortadas Hro. Pulido

240	100x37x3	2 Rulemanes.	100	9	12	14	50	7,5
241	100x37x3	2 Arandelas. Ball.	100	9	12	14	50	7,5
2245	78x37x2,5	3 Arandelas.	78	9	12	12	20	6,35
254	100x37x2,5	2 Arandelas.	100	9	12	14	50	8,5
255	100x37x2,5	2 Arandelas. Ball.	100	9	12	14	50	8,5
256	100x34x1,5	2 Arandelas.	100	9	12	12	100	7,5
259	124x37x3	3 Rulemanes.	124	9	12	18	15	7,5
262	145x45x4	4 Arandelas.	145	9	12	18	8	9,5
265	175x45x4	3 Arandelas.	175	9	12	18	8	9,5

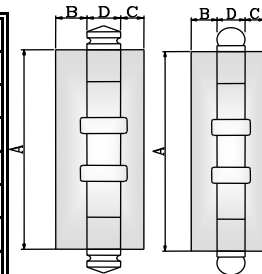

1.F Bisagras Doble Contacto Con Agujeros Hro. Zincado

270	100x80x3	2 Rulemanes.	100	30	30	14	10	7,5
274	124x80x3	4 Rulemanes.	124	30	30	18	10	7,5
280	100x80x3	2 Rulemanes.Mixta	100	30	30	14	10	7,5
285	124x80x3	4 Rulemanes.Mixta	124	30	30	18	10	7,5

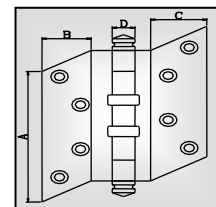



CANTON METALWORK S.A.

Artículo	Tipo	Descripción	A mm	B mm	C mm	D mm	Embalaje x Pares	Ø Perno
----------	------	-------------	---------	---------	---------	---------	---------------------	---------

2.A Bisagras Munición Estilo Bronce Pulido

475	78x78x3	2 Rulemanes.	78	31	31	14	10	7,5
480	100x75x3	2 Rulemanes.	100	31	31	14	10	7,5
485	100x88x3	2 Rulemanes.	100	37	37	14	10	7,5
490	100x100x3	2 Rulemanes.	100	42	42	14	10	7,5
500	124x100x3	4 Rulemanes.	124	41	41	14	10	7,5
505	145x120x4	4 Rulemanes.	145	51	51	18	10	7,5
510	175x130x4	4 Rulemanes.	175	55	55	18	10	7,5
515	100x80x3	2 Rulemanes.D/C	100	30	30	14	10	7,5
517	124x80x3	4 Rulemanes.D/C	124	30	30	14	10	7,5

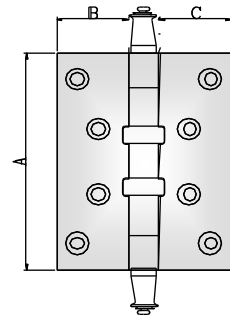

2.B Bisagras Munición Bronce Pulido

565	78x78x3	2 Rulemanes.	78	31	31	14	10	7,5
570	100x75x3	2 Rulemanes.	100	31	31	14	10	7,5
575	100x88x3	2 Rulemanes.	100	37	37	14	10	7,5
580	100x100x3	2 Rulemanes.	100	42	42	14	10	7,5
590	124x100x3	4 Rulemanes.	124	41	41	14	10	7,5
595	145x120x4	4 Rulemanes.	145	51	51	18	5	7,5
600	175x130x4	4 Rulemanes.	175	55	55	18	5	7,5
605	100x80x3	2 Rulemanes. D/C	100	30	30	14	10	7,5
606	124x80x3	4 Rulemanes. D/C	124	30	30	14	10	7,5

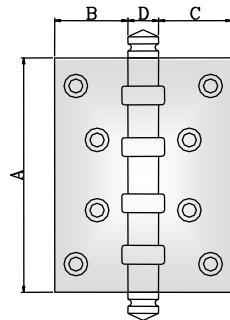

2.C Bisagras Munición Bronce Platil

615	78x78x3	2 Rulemanes.	78	31	31	14	10	7,5
620	100x75x3	2 Rulemanes.	100	31	31	14	10	7,5
625	100x88x3	2 Rulemanes.	100	37	37	14	10	7,5
630	100x100x3	2 Rulemanes.	100	42	42	14	10	7,5
640	124x100x3	4 Rulemanes.	124	41	41	14	10	7,5
645	145x120x4	4 Rulemanes.	145	51	51	18	5	7,5
650	175x130x4	4 Rulemanes.	175	55	55	18	5	7,5
655	100x80x3	2 Rulemanes. D/C	100	30	30	14	10	7,5
656	124x80x3	4 Rulemanes. D/C	124	30	30	14	10	7,5

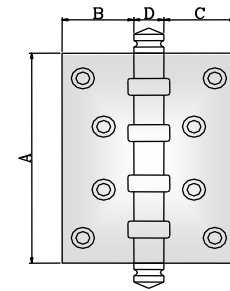

2.D Bisagras Tipo Munición de Hierro zincada con agujero

5210	78x78x2,5	2 Arandelas.	78	31	31	14	12	7,5
5211	100x75x2,5	2 Arandelas. Red.	100	31	31	14	12	8,5
5212	100x75x2,5	2 Arandelas.	100	31	31	14	12	8,5
5213	100x88x2,5	2 Arandelas.	100	37	37	14	12	8,5
5214	100x100x2,5	2 Arandelas.	100	42	42	14	10	8,5
5216	124x100x2,5	4 Arandelas.	124	41	41	14	10	8,5
5217	100x80x2,5	2 Aran.D/C Mixta	100	30	30	14	10	8,5
5218	100x80x2,5	2 Arandelas.D/C	100	30	30	14	10	8,5
5219	124x80x2,5	4 Aran.D/C Mixta	124	30	30	14	10	8,5
5220	124x80x2,5	4 Arandelas.D/C	124	30	30	14	10	8,5

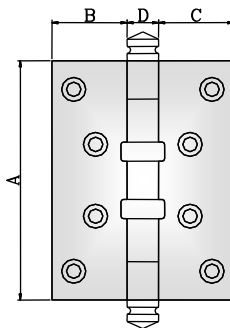

2.E Bisagras Tipo Munición de Hierro sin agujero.

5230	78x78x2,5	2 Arandelas.	78	31	31	14	12	8,5
5235	100x75x2,5	2 Arandelas.	100	31	31	14	12	8,5
5240	100x88x2,5	2 Arandelas.	100	37	37	14	12	8,5
5245	100x100x2,5	2 Arandelas.	100	42	42	14	10	8,5
5247	124x100x2,5	4 Arandelas.	124	41	41	14	10	8,5

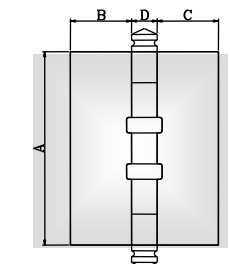



CANTON METALWORK S.A.

Artículo	Tipo	Descripción	A mm	B mm	C mm	D mm	Embalaje x Pares	Ø Perno
----------	------	-------------	---------	---------	---------	---------	---------------------	---------

3.A Bisagras Tipo Munición de Hro con agujero 1 Ala Cort.

5260	78x54x2,5	2 Arandelas.	78	31	9	14	12	8,5
5265	100x54x2,5	2 Arandelas.	100	31	9	14	12	8,5
5270	100x62x2,5	2 Arandelas.	100	37	9	14	12	8,5
5275	100x65x2,5	2 Arandelas.	100	42	9	14	10	8,5
5277	124x65x2,5	4 Arandelas.	124	41	9	14	10	8,5

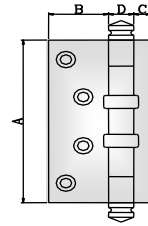

3.B Bisagras Tipo Munición de Hro sin agujero 1 Ala Cort.

5290	78x54x2,5	2 Arandelas.	78	31	9	14	12	8,5
5295	100x54x2,5	2 Arandelas.	100	31	9	14	12	8,5
5300	100x62x2,5	2 Arandelas.	100	37	9	14	12	8,5
5305	100x65x2,5	2 Arandelas.	100	42	9	14	10	8,5
5307	124x65x2,5	4 Arandelas.	124	41	9	18	10	8,5

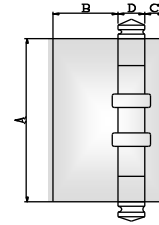

3.C Bisagras Tipo Munición de Bronce Pulido

5510	78x78x2,5	2 Arandelas.	78	31	31	14	10	8,5
5520	100x75x2,5	2 Arandelas.	100	31	31	14	10	8,5
5525	100x88x2,5	2 Arandelas.	100	37	37	14	10	8,5
5530	100x100x2,5	2 Arandelas.	100	42	42	14	10	8,5
5540	124x100x2,5	4 Arandelas.	124	41	41	14	10	8,5
5545	100x80x2,5	2 Arandelas.D/C	100	30	30	14	10	8,5
5547	124x80x2,5	4 Arandelas.D/C	124	30	30	14	10	8,5

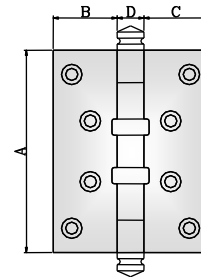

3.D Bisagras Tipo Munición de Bronce Platil

5549	78x78x2,5	2 Arandelas.	78	31	31	14	10	8,5
5550	100x75x2,5	2 Arandelas.	100	31	31	14	10	8,5
5560	100x88x2,5	2 Arandelas.	100	37	37	14	10	8,5
5570	100x100x2,5	2 Arandelas.	100	42	42	14	10	8,5
5572	124x100x2,5	4 Arandelas.	124	41	41	14	10	8,5
5575	100x80x2,5	2 Arandelas.D/C	100	30	30	14	10	8,5
5577	124x80x2,5	4 Arandelas.D/C	124	30	30	14	10	8,5

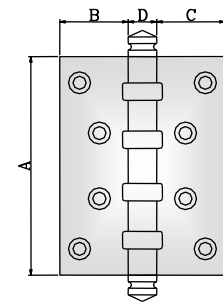

CANTON METALWORK S.A**ACERO INOXIDABLE****Hierro y Bronce*****Bisagras Linea 3 rodamientos***

Artículo	Tipo	Descripción	A mm	B mm	C mm	D mm	Ø Perno	Embalaje x Pares
----------	------	-------------	---------	---------	---------	---------	---------	---------------------

Bisagras Linea 3 Rodamientos con Agujero

4.A

2106	78x78x2,5	Der.-Izq.Canto Red.	78	31	31	12	6,35	10
2105	78x78x2,5	Derecha-Izquierda	78	31	31	12	6,35	10
2111	100x75x2,5	Der.-Izq.Canto Red.	100	31	31	12	6,35	10
2110	100x75x2,5	Derecha-Izquierda	100	31	31	12	6,35	10
2195	78x54x2,5	Der.-Izq.1Ala Cor.	78	31	9	12	6,35	10
2200	100x54x2,5	Der.-Izq.1 Ala Cor.	100	31	9	12	6,35	10

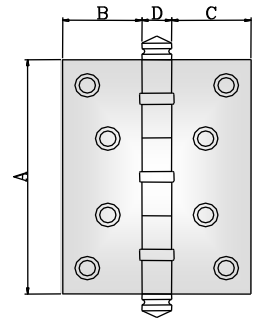
***Bisagras Linea 3 Rodamientos sin Agujero***

4.B

2150	78x78x2,5	Derecha-Izquierda	78	31	31	12	6,35	10
2155	100x75x2,5	Derecha-Izquierda	100	31	31	12	6,35	10
2215	78x54x2,5	Der.-Izq.1Ala Cor.	78	31	9	12	6,35	10
2220	100x54x2,5	Der.-Izq.1Ala Cor.	100	31	9	12	6,35	10

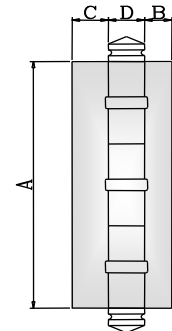
***Bisagras Linea 3 Rodamientos Cortadas***

4.C

2245	78x37x2,5	Derecha-Izquierda	78	12	12	12	6,35	10/20
2254	100x37x2,5	Derecha-Izquierda	100	12	12	12	6,35	20/50



CANTON METALWORK S.A.

Artículo	Tipo	Descripción	A mm	B mm	C mm	D mm	Ø Trompo	Embalaje x Pares
----------	------	-------------	------	------	------	------	----------	------------------

5.A Bisagras Carroceras con o sin agujeros en Hierro

250	65x37x2,5	Cortada S/A	65	9	12	----	7,5	30 x Caja
305	65x67x2,5	Zincada C/A	65	26	26	----	7,5	25 x Caja
310	65x100x2,5	Zincada C/A	65	43	43	----	7,5	15 x Caja
311	65x100x2,5	Pulido S/A	65	43	43	----	7,5	15 x Caja
312	65x100x2,5	C/A 1 ala cort.	65	43	9	----	7,5	15 x Caja
315	65x67x2,5	Pulido S/A	65	26	26	----	7,5	25 x Caja
325	100x100x3	Zincada C/A	100	42	42	----	7,5	10 x Caja
330	100x100x3	Pulido S/A	100	42	42	----	7,5	10 x Caja
290	50x110x2,0	Carrocera 3 agu. C/A	51	51	51	----	6	12 x Caja
291	60x150x2,8	Carrocera 4 agu. C/A	61	69	69	----	6,21	12 x Caja
292	75x140x2,8	Carrocera 4 agu. C/A	74	67	67	----	6,21	12 x Caja

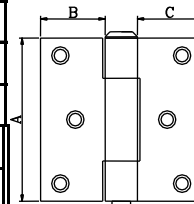
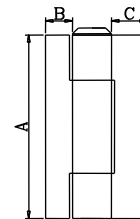

5.B Ficha Para Soldar

340	14x40	Trafilada S/A	42	2	13	16	8	40 x Bolsa
345	14x60	Trafilada S/A	62	2	13	16	8	20 x Bolsa
350	14x80	Trafilada S/A	82	2	13	16	8	20 x Bolsa

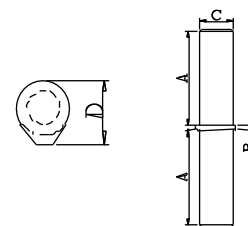

5.C Pomela Tipo 110mm Hro. Zincado

384/89	90x67	Der./Izq. Rec. D/C	75	28	25	----	6,8	20
385/90	90x67	Der./Izq. Red. D/C	75	28	25	----	6,8	20
395/400	90x65	Der./Izq. Red. S/C	75	25	25	----	6,8	20
396/99	90x65	Der./Izq. Rec. S/C	75	25	25	----	6,8	20
405/10	90x70 mixta	Der./Izq. Red. D/C	75	28	25	----	6,8	20
406/09	90x70 mixta	Der./Izq. Rec. D/C	75	28	25	----	6,8	20
415/20	90x65 mixta	Der./Izq. Red. S/C	75	25	25	----	6,8	20
416/19	90x65 mixta	Der./Izq. Rec. S/C	75	25	25	----	6,8	20

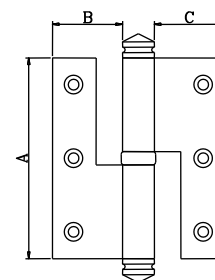

CANTON METALWORK S.A



CANTON METALWORK S.A.

Artículo	Tipo	Descripción	A mm	B mm	C mm	D mm	Ø Trompo	Embalaje x Pares
----------	------	-------------	------	------	------	------	----------	------------------

6.A Pomela Tipo 110mm Hro. Estilo Florentino

426/27	130x67	Der./Izq. Red. D/C	75	28	25	----	6,8	20
428/29	130x65	Der./Izq. Red. S/C	75	25	25	----	6,8	20

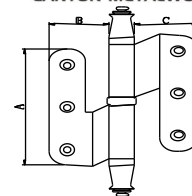

6.B Pomela Tipo 110mm Bronce Pulido

665/70	90x67	Der./Izq. Red. D/C	75	28	25	----	6,8	20
666/69	90x67	Der./Izq. Rec. D/C	75	28	25	----	6,8	20
675/80	90x65	Der./Izq. Red. S/C	75	25	25	----	6,8	20
676/79	90x65	Der./Izq. Rec. S/C	75	25	25	----	6,8	20

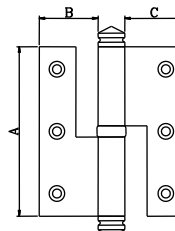

6.C Pomela Tipo 110mm Bronce Platil

685/90	90x67	Der./Izq. Red. D/C	75	28	25	----	6,8	20
686/87	90x67	Der./Izq. Rec. D/C	75	28	25	----	6,8	20
695/98	90x65	Der./Izq. Red. S/C	75	25	25	----	6,8	20
696/97	90x65	Der./Izq. Rec. S/C	75	25	25	----	6,8	20

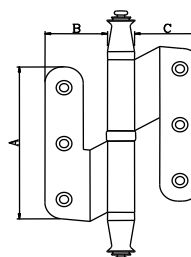

6.D Pomela Tipo 110mm Bronce Estilo

706/08	130x67 Pul.	Der./Izq. Red. D/C	75	28	25	----	6,8	20
710/12	130x67 Pul.	Der./Izq. Red. S/C	75	25	25	----	6,8	20
714/16	130x67 Vjo.	Der./Izq. Red. D/C	75	28	25	----	6,8	20
718/20	130x65 Vjo.	Der./Izq. Red. S/C	75	25	25	----	6,8	20

6.E Ficha de 3 y 5 Agujeros Para Carpinteros de Hro. Zincado

374	80-33x2,5	Reversible	77	33	33	37	8	20
1020	100-25x2,5	3 Agu. Rev.	103	25	25	50	8	20
1050	100-33x2,5	5 Agu. Rev.	103	33	33	50	8	20
3016	100-17x2 Red.	3 Agu. Rev.	103	17	17	50	8	20
3020	100-25x2	3 Agu. Rev.	103	25	25	50	8	20
3050	100-33x2	5 Agu. Rev.	103	33	33	50	8	20
3710	120-27x2	3 Agu. Rev.	123	27	27	60	8	20
3730	120-37x2	5 Agu. Rev.	123	37	37	60	8	20
4016	100-17x1,5	3 Agu. Rev.	103	17	17	50	8	20
4020	100-25x1,5	3 Agu. Rev.	103	25	25	50	8	20
4050	100-33x1,5	5 Agu. Rev.	103	33	33	50	8	20
4710	120-27x1,5	3 Agu. Rev.	123	27	27	60	8	20
4730	120-37x1,5	5 Agu. Rev.	123	37	37	60	8	20
4007	80 x 20 x 1,25	Ficha 3 Aguj.	83	22	22	39	6,8	12

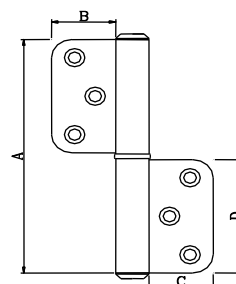

6.F Ficha de 3 y 5 Agujeros Para Carpinteros en Bronce Pulido

4007	80 x 20 x 1,25	Ficha 3 Aguj.	83	22	22	39	6,8	12
3810	120-27x2	3 Agu. Rev.	123	27	27	60	8	20
3830	120-37x2	5 Agu. Rev.	123	37	37	60	8	20
4810	120-27x1,5	3 Agu. Rev.	123	27	27	60	8	20
4830	120-37x1,5	5 Agu. Rev.	123	37	37	60	8	20

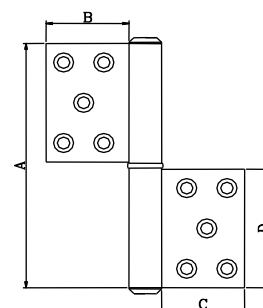

CANTON METALWORK S.A



CANTON METALWORK S.A.

Artículo	Tipo	Descripción	A mm	B mm	C mm	D mm	Ø Trompo	Embalaje x Pares
----------	------	-------------	------	------	------	------	----------	------------------

7.A Ficha de 3 y 5 Agujeros Mixta para Herrero

1080	100-25x2,5	3 Agu. Rev.	103	25	25	50	8	20
1110	100-33x2,5	5 Agu. Rev.	103	33	33	50	8	20
3180	100-25x2	3 Agu. Rev.	103	25	25	50	8	20
3110	100-33x2	5 Agu. Rev.	103	33	33	50	8	20
3750	120-27x2	3 Agu. Rev.	123	27	27	60	8	20
3770	120-37x2	5 Agu. Rev.	123	37	37	60	8	20
4180	100-25x1,5	3 Agu. Rev.	103	25	25	50	8	20
4110	100-33x1,5	5 Agu. Rev.	103	33	33	50	8	20
4750	120-27x1,5	3 Agu. Rev.	123	27	27	60	8	20
4770	120-37x1,5	5 Agu. Rev.	123	37	37	60	8	20

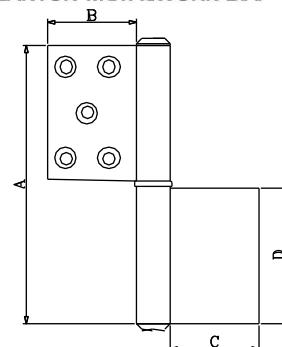

7.B Ficha Herrero Perilla Plana Hro. Pulido Sin Agujero

1126	60-33x2,5	Rev. S/A	61	33	33	29	8	20
1140	80-33x2,5	Rev. S/A	77	33	33	37	8	20
1150	120-37x2,5	Rev. S/A	123	37	37	60	8	20
1170	100-33x2,5	Rev. S/A	103	33	33	50	8	20
1173	80-22x2,5	Rev. S/A	77	22	22	37	8	20
1186	80-8-33x2,5	Rev. S/A	77	8	33	37	8	20
1203	60-22x2,5	Rev. S/A	61	22	22	29	8	20
1217	60-8-33x2,5	Rev. S/A	61	8	33	29	8	40
1246	100-8x2,5	Rev. S/A	103	8	8	50	8	20
1260	80-8x2,5	Rev. S/A	77	8	8	37	8	40
1290	60-8x2,5	Rev. S/A	61	8	8	29	8	40
3226	60-33x2	Rev. S/A	61	33	33	29	8	20
3240	80-33x2	Rev. S/A	77	33	33	37	8	20
3270	100-33x2	Rev. S/A	103	33	33	50	8	20
3273	80-22x2	Rev. S/A	77	22	22	37	8	20
3286	80-8-33x2	Rev. S/A	77	8	33	37	8	20
3303	60-22x2	Rev. S/A	61	22	22	29	8	20
3317	60-8-33x2	Rev. S/A	61	8	33	29	8	40
3346	100-8x2	Rev. S/A	103	8	8	50	8	20
3360	80-8x2	Rev. S/A	77	8	8	37	8	40
3390	60-8x2	Rev. S/A	61	8	8	29	8	40
4226	60-33x1,5	Rev. S/A	61	33	33	29	8	20
4240	80-33x1,5	Rev. S/A	77	33	33	37	8	20
4270	100-33x1,5	Rev. S/A	103	33	33	50	8	20
4273	80-22x1,5	Rev. S/A	77	22	22	37	8	20
4286	80-8-33x1,5	Rev. S/A	77	8	33	37	8	20
4303	60-22x1,5	Rev. S/A	61	22	22	29	8	20
4317	60-8-33x1,5	Rev. S/A	59	8	33	29	8	40
4346	100-8x1,5	Rev. S/A	103	8	8	50	8	20
4360	80-8x1,5	Rev. S/A	77	8	8	37	8	40
4390	60-8x1,5	Rev. S/A	61	8	8	29	8	40
4008	80x20x1,25	Rev. S/A	83	22	22	39	6,8	12

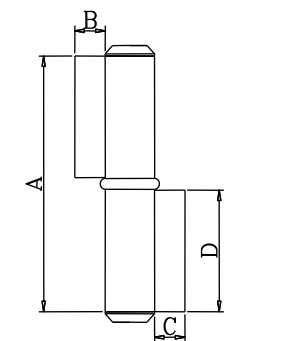
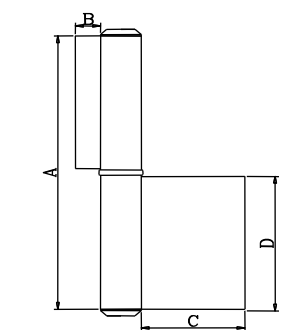
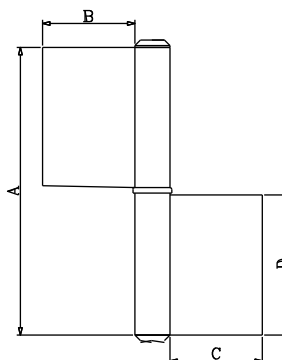

Artículo	Tipo	Descripción	A mm	B mm	C mm	D mm	Ø Trompo	Embalaje x Pares
----------	------	-------------	---------	---------	---------	---------	----------	---------------------



CANTON METALWORK S.A.

8.A Bisagras Para Mueble en Hierro

1310/15	50x46x1,6	S/A Hro. Pulido	50	19	19	----	4,5	20
1320/25	50x46x1,6	Der./Izq. Niq.	50	19	19	----	4,5	20
1330/35	50x46x1,6	Der./Izq. Bcdo.	50	19	19	----	4,5	20
1340/45	63x50x1,6	Der./Izq. Niq.	63	21	21	----	4,5	20
1350/55	63x50x1,6	Der./Izq. Bcdo.	63	21	21	----	4,5	20

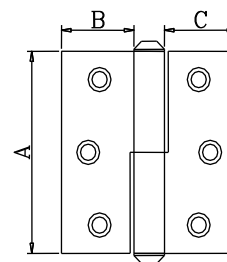

8.B Bisagras Para Mueble en Bronce

1360/65	50x46x1,6	Der./Izq. Pulido	50	19	19	----	4,5	20
1370/75	50x46x1,6	Der./Izq. Platil	50	19	19	----	4,5	20
1380/85	63x50x1,6	Der./Izq. Pulido	63	21	21	----	4,5	20
1390/95	63x50x1,6	Der./Izq. Platil	63	21	21	----	4,5	20

8.C Bisagras Ficha Mixta Hro. Pulido

1415/20	50x46x1,6	Der./Izq.	50	19	19	----	4,5	25
1425/30	63x50x1,6	Der./Izq.	63	21	21	----	4,5	25

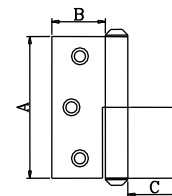

8.D Bisagras Ficha Para Soldar Hro. Pulido

1450/55	50x46x1,6	Der./Izq.	25	19	19	----	4,5	25
1460/65	63x50x1,6	Der./Izq.	31,5	21	21	----	4,5	25

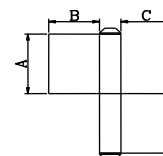

8.E Bisagras 5005 Sin Agujeros Hro. Pulido

1471	5005	25 mm	25	8	8	----	1,5	100
1472	5005	32 mm	32	9	9	----	1,6	100
1473	5005	38 mm	38	10	10	----	2	50
1474	5005	51 mm	51	13	13	----	2,45	50
1475	5005	63 mm	63	13	13	----	2,5	50

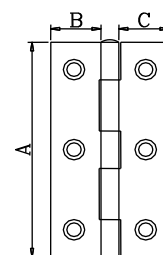

8.F Bisagras 5005 Con Agujeros Hro. Pulido

1485	5005	25 mm	25	8	8	----	1,5	100
1490	5005	32 mm	32	9	9	----	1,6	100
1495	5005	38 mm	38	10	10	----	2	50
1500	5005	51 mm	51	13	13	----	2,45	50
1505	5005	63 mm	63	13	13	----	2,5	50

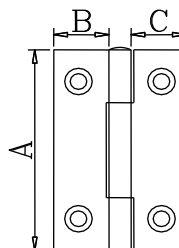

8.G Bisagras 5005 Con Agujeros Hro. Bronceado

1535	5005	20 mm	20	6	6	----	1,5	100
1540	5005	25 mm	25	8	8	----	1,5	100
1545	5005	32 mm	32	9	9	----	1,6	100
1550	5005	38 mm	38	10	10	----	2	50
1555	5005	51 mm	51	13	13	----	2,45	50
1560	5005	63 mm	63	13	13	----	2,5	50

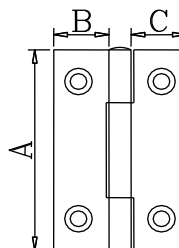

Artículo	Tipo	Descripción	A mm	B mm	C mm	D mm	Ø Trompo	Embalaje x Pares
----------	------	-------------	------	------	------	------	----------	------------------



CANTON METALWORK S.A.

9.A **Bisagras 5005 Con Agujeros Bronce Pulido**

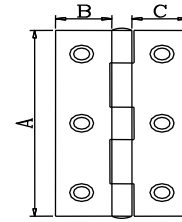

1645	5005	25 mm	25	8	8	----	1,5	100
1650	5005	32 mm	32	9	9	----	1,6	100
1655	5005	38 mm	38	10	10	----	2	50
1660	5005	51 mm	51	13	13	----	2,45	50
1665	5005	63 mm	63	13	13	----	2,5	50

9.B **Bisagras para Mueble Tipo "1842" Hierro Pulido**



1710	1842	25 mm	25	19	19	4,8	2,7	24
1720	1842	32 mm	32	22	22	4,8	2,7	24
1730	1842	38 mm	38	26	26	4,8	2,7	24
1740	1842	51 mm	51	28	28	4,8	2,7	12
1750	1842	63 mm	63	31	31	5,8	3	12

9.C **Bisagras Pestaña y Doble Pestaña**

Art.	Tipo	Descripción	A mm	B mm	C mm	D mm	E mm	Espesor
4780	Pestaña N°3	Doble Pestaña Zincado	6	10	14	51	-	1,25
4785	Pestaña N°4	Pestaña Zincado	6	10	14	51	24	1,25
4790	Pestaña N°3	Doble Pest. Bronceado	6	10	14	51	-	1,25
4795	Pestaña N°4	Pestaña Bronceado	6	10	14	51	24	1,25
4850	Pestaña N°3	Doble Pest. Bronce Pul.	6	10	14	51	-	1,25
4860	Pestaña N°4	Pestaña Bronce Pul.	6	10	14	51	24	1,25

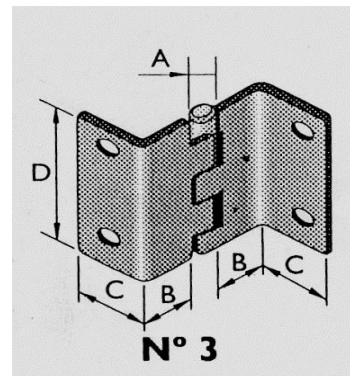
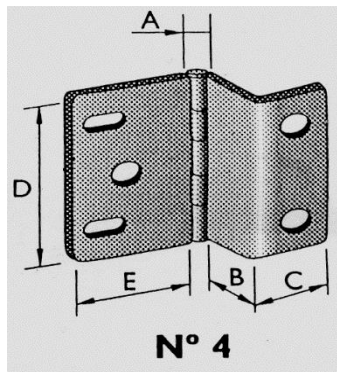

Artículo	Tipo	Descripción
----------	------	-------------



CANTON METALWORK S.A.

10.A Accesorios Hierro Zincado

730	C/U	Ruleman Chico	Pr.x Uni
735	C/U	Ruleman Grande	Pr.x Uni
736	C/U	Arandela 8/14x7mm	Pr.x Uni
737	C/U	Arandela 8.75/17x7mm	Pr.x Uni
738	C/U	Arandela 6.5/14x6mm	Pr.x Uni
739	C/U	Arandela 10/22x8.6mm	Pr.x Uni
740	C/U	Perilla 7.5/14x8mm	Pr.x Uni
745	C/U	Perilla 9.5/18x9mm	Pr.x Uni
746	C/U	Per.(110) 7/12x8mm	Pr.x Uni
747	C/U	Per.Plana 8.3/14x8mm	Pr.x Uni
750	C/U	Perno 7.5x78mm (3")	Pr.x Uni
755	C/U	Perno 7.5x100mm (4")	Pr.x Uni
760	C/U	Perno 7.5x124mm (5")	Pr.x Uni
765	C/U	Perno 9.5x145mm (6")	Pr.x Uni
770	C/U	Perno 9.5x175mm (7")	Pr.x Uni
772	C/U	Perno 8.5x100mm (4")	Pr.x Uni
775	C/U	Perno 7/12x22x22mm	Pr.x Uni
780	C/U	Perno 8/14x22x22mm	Pr.x Uni
795	C/U	Remache 4.5/8x50mm	Pr.x Uni

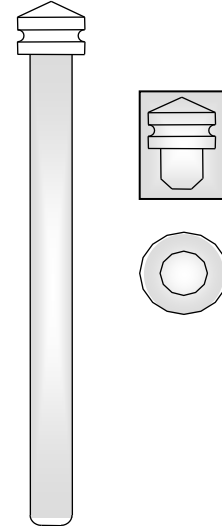
10.B Accesorios Bronce Pulido

805	C/U	Ruleman Chico	Pr.x Uni
810	C/U	Ruleman Grande	Pr.x Uni
815	C/U	Perilla 7.5/14x8mm	Pr.x Uni
820	C/U	Perilla 9.5/18x9mm	Pr.x Uni
821	C/U	Perilla 7/12x8mm	Pr.x Uni
822	C/U	Perilla 8/14x8mm	Pr.x Uni
823	C/U	Arandela 8.75/17x7mm	Pr.x Uni
825	C/U	Perno 7.5x78mm	Pr.x Uni
830	C/U	Perno 7.5x100mm	Pr.x Uni
835	C/U	Perno 7.5x124mm	Pr.x Uni
840	C/U	Perno 9.5x145mm	Pr.x Uni
845	C/U	Perno 9.5x175mm	Pr.x Uni
846	C/U	Perno 7/12x22x22mm	Pr.x Uni
847	C/U	Perno 8/14x22x22mm	Pr.x Uni
848	C/U	Perno 8.5/14x90mm	Pr.x Uni

10.c Accesorios para Fichas y Carroceras

1121	C/U	Trompos para 4007 / 4008	Pr.x Uni
1141	C/U	Trompos para 3710/3730/4710/4730	Pr.x Uni
1140	C/U	Trompos para 1260	Pr.x Uni
1130	C/U	Trompos para 1290	Pr.x Uni
1069	C/U	Perillas para 4007 / 4008	Pr.x Uni
1231	C/U	Perillas para Fichas 2/1,5 mm Hro.Pulido	Pr.x Uni
1230	C/U	Perillas para Fichas 2,5 mm Hro.Pulido	Pr.x Uni
1195	C/U	Pernos para Carroceras (250/305/310/311,etc)	Pr.x Uni
1231-A	C/U	Perillas para Fichas 2/1,5 mm Zincado	Pr.x Uni
1230-A	C/U	Perillas para Fichas 2,5 mm Zincado	Pr.x Uni

CANTON METALWORK S.A

Artículo	Tipo	Descripción	A mm	B mm	C mm	Ø Trompo	Caja x Pares
----------	------	-------------	---------	---------	---------	-------------	-----------------

11.A Pomela H 110mm Hierro

5384/5389	110x60	Der./Izq. Rec. D/C	110	0	0	0	15
5385/5390	110x60	Der./Izq. Red. D/C	110	0	0	0	15
5395/5400	110x65	Der./Izq. Red. S/C	110	26	26	6	15
5396/5399	110x65	Der./Izq. Rec. S/C	110	26	26	6	15
5405/5410	110x70 mixta	Der./Izq. Red. D/C	110	0	0	0	15
5406/5409	110x70 mixta	Der./Izq. Rec. D/C	110	0	0	0	15
5415/5420	110x65 mixta	Der./Izq. Red. S/C	110	26	33	6	15
5416/5419	110x65 mixta	Der./Izq. Rec. S/C	110	26	33	6	15



12.B Pomela H 140mm Hierro

5393/5394	140x70	Der./Izq. Rec. D/C	140	31	28	8	10
5391/5392	140x70	Der./Izq. Red. D/C	140	31	28	8	10
5401/5402	140x75	Der./Izq. Red. S/C	140	31	31	8	10
5403/5404	140x75	Der./Izq. Rec. S/C	140	31	31	8	10
5411/5412	140x65 mixta	Der./Izq. Red. D/C	140	28	26	8	10
5413/5414	140x65 mixta	Der./Izq. Rec. D/C	140	28	26	8	10
5421/5422	140x70 mixta	Der./Izq. Red. S/C	140	31	26	8	10
5423/5424	140x70 mixta	Der./Izq. Rec. S/C	140	31	26	8	10





ACERO INOXIDABLE 304L

Artículo	Tipo	Descripción	A mm	B mm	C mm	D mm	Embalaje x Pares	Ø EJE
----------	------	-------------	------	------	------	------	------------------	-------

12.A *Bisagras Munición Acero Inoxidable 304L*

3105	78x78x3	2 Rulemanes	78	31	31	14	1	14
3110	100x75x3	2 Rulemanes	100	31	31	14	1	14
3210	100x75x2	sin rodamientos	100	31	31	12	1	12
3115	100x88x3	2 Rulemanes	100	37	37	14	1	14
3120	100x100x3	2 Rulemanes	100	42	42	14	1	14
3130	124x100x3	4 Rulemanes	124	42	42	14	1	14



12.A *Bisagras Munición Acero Inoxidable 304L*

3268	78x70x3 D/C	2 Rulemanes	78	28	28	14	1	14
3270	100x80x3 D/C	2 Rulemanes	100	30	30	14	1	14
5270	100x70x3 mm	D/C 90°	100	20	25	14	1	14
3274	124x80x3 D/C	4 Rulemanes	124	30	30	18	1	14



12.B *Bisagras Munición Acero Inoxidable 304L Cortadas*

3245	78x37x3	2 Rulemanes	78	9	12	14	1	14
3240	100x37x3	2 Rulemanes	100	9	12	14	1	14
3259	124x37x3	4 Rulemanes	124	9	12	14	1	14



12.C *Bisagras Munición Acero Inoxidable 304L un Ala Cortada*

3195	78x54x3	2 Rulemanes	78	31	9	14	1	14
3200	100x54x3	2 Rulemanes	100	31	9	14	1	14
3205	100x62x3	2 Rulemanes	100	37	9	14	1	14
3230	100x65x3	2 Rulemanes	100	42	9	14	1	14
3232	124x65x3	4 Rulemanes	124	41	9	18	1	14



12.D *Bisagras Munición Acero Inoxidable Simil Bronce*

6105	78x78x3	2 Rulemanes	78	31	31	14	1	14
6110	100x75x3	2 Rulemanes	100	31	31	14	1	14
6115	100x88x3	2 Rulemanes	100	37	37	14	1	14
6120	100x100x3	2 Rulemanes	100	42	42	14	1	14
6130	124x100x3	4 Rulemanes	124	42	42	14	1	14
6268	78x70x3 D/C	2 Rulemanes	78	28	28	14	1	14
6270	100x80x3 D/C	2 Rulemanes	100	30	30	14	1	14
6274	124x80x3 D/C	4 Rulemanes	124	30	30	18	1	14



12.E *Bisagras Munición Acero Inoxidable 304L con Perilla de Seguridad*

5110	100x75x3	2 Rulemanes	100	31	31	14	1	14
5115	100x88x3	2 Rulemanes	100	37	37	14	1	14



CANTON METALWORK S.A

Artículo	Tipo	Descripción	A mm	B mm	C mm	Ø Trompo	Caja x Pares	
----------	------	-------------	---------	---------	---------	----------	-----------------	--



CANTON METALWORK S.A.

13.A Pomela H 100 mm Acero Inoxidable

3396	100x57x2 mm	Derecha S/C	100	23	23	6	6	
3399	100x57x2 mm	Izquierda S/C	100	23	23	6	6	
3416	100x57 mixta	Derecha S/C	100	23	23	6	6	
3419	100x57 mixta	Izquierda S/C	100	23	23	6	6	

13.B Pomela H 140 mm Acero Inoxidable

3403	140x70x3 mm	Derecha S/C	140	28	28	8	6	
3404	140x70x3 mm	Izquierda S/C	140	28	28	8	6	
3423	140x70 mixta	Derecha S/C	140	28	28	8	6	
3424	140x70 mixta	Izquierda S/C	140	28	28	8	6	

**13.C Bisagras Continuas de Acero Inoxidable**

ch32	31,75 mm x 1830 mm x 1,0 mm	14	14	Ø 3,8	
ch38	38,10 mm x 1830 mm x 1,2 mm	16	16	Ø 6,10	
ch50	50,4 mm x 1830 mm x 1,2 mm	22	22	Ø 6,4	
ch76	76 mm x 1830 mm x 1,5 mm	34	34	Ø 7	

**13.D Ficha 5005 hierro bronceado -importadas**

5005CH17	17 * 6 * 0,7mm	24
5005CH25	25 * 7 * 0,7mm	24
5005CH37	37 * 12 * 1mm	12
5005CH50	50 * 14 * 1mm	12
5005CH63	63,5 * 15 * 1mm	12
5005CH73	73 * 19 * 1,2mm	12
5005CH89	89 * 25 * 1,5 mm	12
5005CH100	100 * 28 * 1,5 mm	6

**13.E Ficha 5005 Acero Inoxidable**

5005InoxCH64	64 x 40 x 1 mm	40
--------------	----------------	----



CANTON METALWORK S.A.

Bisagras Doble Acción Acero Inoxidable

Artículo	A	B	C	D	E	F	G	H	Soporta kg x Par
0003	75	38	19	24	18	23	4,8	70	10
0004	100	40	19	26	18	23	5,5	70	12
0005	125	45	25	29	23	26	6,8	86	30
0006	150	45	25	29	23	27	6,8	86	34

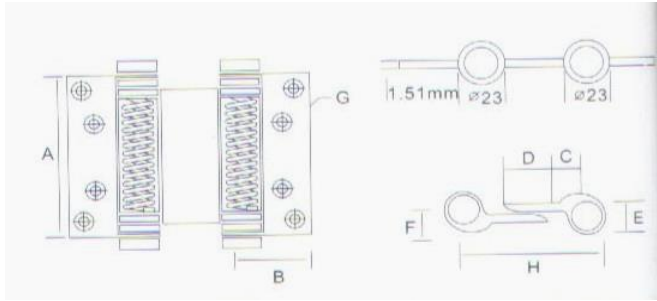

Bisagras Simple Acción Acero Inoxidable

Artículo	A	B	C	D	E	F	G	H
0013	75	48	22	25	18	12	5,5	79
0014	100	48	22	25	18	12	5,5	79
0015	125	56	26	28	23	14	6,8	90
0016	150	56	26	28	23	14	6,8	90

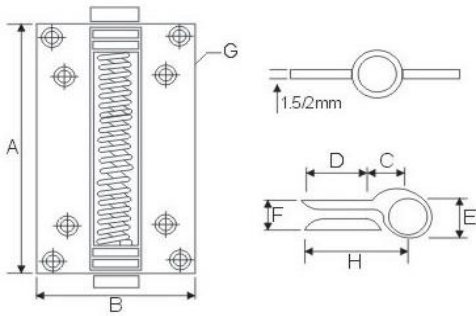

CANTON METALWORK S.A

Artículo	Tipo	Descripción	A mm	B mm	C mm	Ø Ext.Perno
----------	------	-------------	---------	---------	---------	----------------



CANTON METALWORK S.A.

14.A Bisagra p/plegadizas Acero Inoxidable 304L

3540	00x75x2,5 mm	2 rulemanes	100	38	25	12
------	--------------	-------------	-----	----	----	----



14.B Bisagras Carroceras Acero Inoxidable 304L

3501	00x150x3mm		100	68	68	14
3502	00x200x3mm		100	93	93	14



14.C Pomela cierre automático Acero Inoxidable 304 L

3530	00x75x2,5mm	derecha	100	31	31	12
3531	00x75x2,5mm	izquierda	100	31	31	12



14.D Pomela Acero Inoxidable 304 L

3520	90x75x2,5mm	derecha	90	31	31	12
3521	90x75x2,5mm	izquierda	90	31	31	12



14.E Ficha 4 agujeros 100-37x3 mm Acero Inoxidable

3510	100-37x3mm	derecha	100	37	37	14
3511	100-37x3mm	izquierda	100	37	37	14





Manijas Tubos Doble Balancín con boca llave. Acero Inoxidable

CMTHL602	
CMTHL606	
CMTHL608	
CMTHL609	
CMTHL610	
CMTHL612	
CMTHL616	
CMTHL619	

L	H	D
140	65	22



CANTON METALWORK S.A.

17.A

Manijón Curvo/ Barral de Acero Inoxidable 304

Artículo	L	DT	DC	DR	ET	Embalaje	
gbh300	300 mm	25 mm	300 mm	58 mm	1 mm	2 unidades	
gbh400	400 mm	25 mm	400 mm	58 mm	1 mm	2 unidades	
gbh500	500 mm	25 mm	500 mm	58 mm	1 mm	2 unidades	



17.B

Manijón Recto de Acero Inoxidable 304

Artículo	L	DT	DC	DR	ET	Embalaje	
BHR400	400 mm	38 mm	240 mm	58 mm	1 mm	4 unidades	
BHR500	500 mm	38 mm	340 mm	58 mm	1 mm	2 unidades	
BHR600	600 mm	38 mm	440 mm	58 mm	1 mm	2 unidades	
BHR800	800 mm	38 mm	600 mm	58 mm	1 mm	2 unidades	
BHR1000	1000 mm	38 mm	800 mm	58 mm	1 mm	2 unidades	

L : Longitud Total DT: diámetro tubo DC: distancia entre centros DR: diámetro rosetas ET: Espesor Tubo



NUMEROS Y LETRAS EN ACERO INOXIDABLE



CANTON METALWORK S.A.

Números en Acero Inoxidable 304 Esmerilado

Artículo	Medida	Tipografía	Espesor	Precio U\$S
nro60	60 mm	Arial Black	1	1,71
nro80	80 mm	Arial Black	1	2,73
nro100	100 mm	Arial Black	1	3,86
nro120	120 mm	Arial Black	1	4,43
nro150	150 mm	Arial Black	1	5,81
nro200	200 mm	Arial Black	1	10,09
nro250	200 mm	Arial Black	1	16,39
nro300	300 mm	Arial Black	1	24,07

0123456789

Letras en Acero Inoxidable 304 Esmerilado

Artículo	Medida	Tipografía	Espesor	Precio U\$S
let60	60 mm	Arial Black	1	1,71
let80	80 mm	Arial Black	1	2,73
let120	120 mm	Arial Black	1	4,43
let150	150 mm	Arial Black	1	5,81
let200	200 mm	Arial Black	1,5	10,09

















ABCDEFGHI

- Se realizan tipografías, tamaños y diseños a medida.

SEÑALETICA ACERO INOXIDABLE



CANTON METALWORK S.A.

artículo medida		artículo medida	
	car001 100x100mm 150x150mm 200x200mm		car009 100x100mm 150x150mm 200x200mm
	car002 100x100mm 150x150mm 200x200mm		car010 100x100mm 150x150mm 200x200mm
	car003 100x100mm 150x150mm 200x200mm		car011 100x100mm 150x150mm 200x200mm
	car004 100x100mm 150x150mm 200x200mm		car012 100x100mm 150x150mm 200x200mm
	car005 100x100mm 150x150mm 200x200mm		car013 100x100mm 150x150mm 200x200mm
	car006 100x100mm 150x150mm 200x200mm		car014 100x100mm 150x150mm 200x200mm
	car007 100x100mm 150x150mm 200x200mm		car015 100x100mm 150x150mm 200x200mm
	car008 100x100mm 150x150mm 200x200mm		car016 100x100mm 150x150mm 200x200mm

- Se realizan tamaños y diseños a medida.

Accesorios de Baño en Acero Inoxidable 304



CANTON METALWORK S.A.

Artículo	Descripción	Medidas	Material	
BHPH	PORTA PAPEL HIGIENICO	DIAMETRO DE BASE 50 MM	ACERO INOXIDABLE SS304	
		DIAMETRO DE TUBO 19 MM		
		LARGO 65 MM		
BHTR	ARO DE TOALLA	DIAMETRO DE BASE 50 MM	ACERO INOXIDABLE SS304	
		DIAMETRO DE ARO 147 MM		
		DIAMETRO DE TUBO 9 MM		
BHTR	TOALLERO	DIAMETRO DE BASE 50 MM	ACERO INOXIDABLE SS304	
		LARGO 602 MM		
		DIAMETRO DE TUBO 19 MM		
BHTH	PERCHA TOALLA	DIAMETRO DE BASE 50 MM	ACERO INOXIDABLE SS304	
		DIAMETRO DE TUBO 16 MM		
		LARGO 32 MM		
BHTBA	ESTANTE TOALLERO	LARGO 600 MM	ACERO INOXIDABLE SS304	